

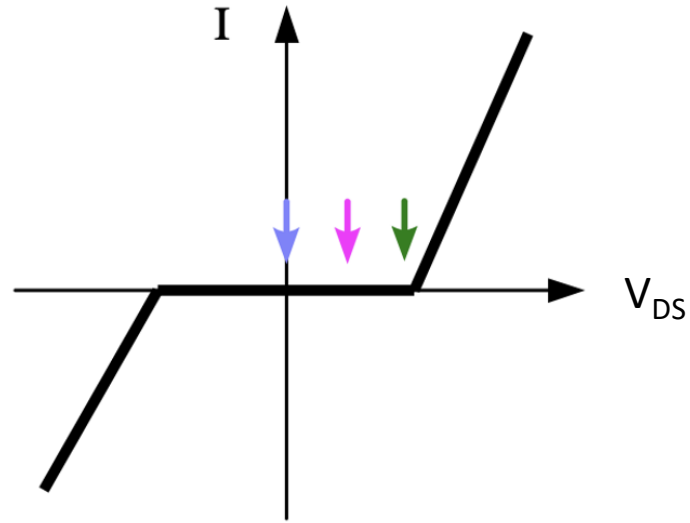

9.1 Quantum dot: Coulomb blockade

Sketch the energy diagram of the quantum dot in the situations corresponding to the arrows

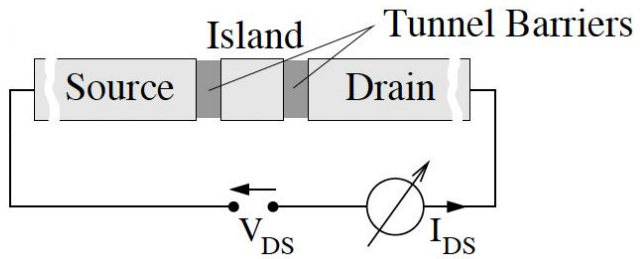



9.1 Quantum dot: Coulomb blockade - Solution

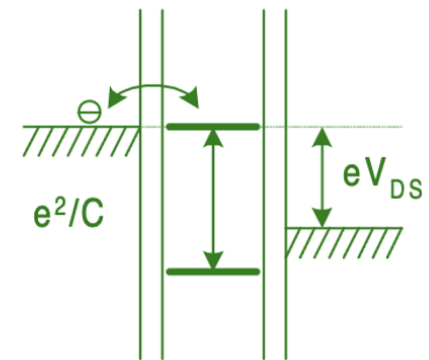
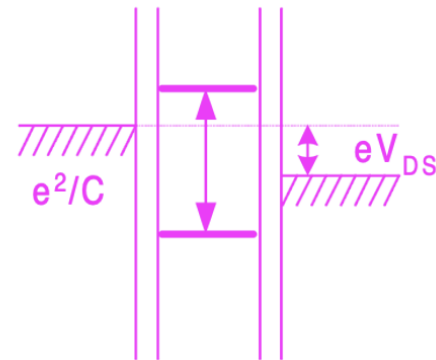
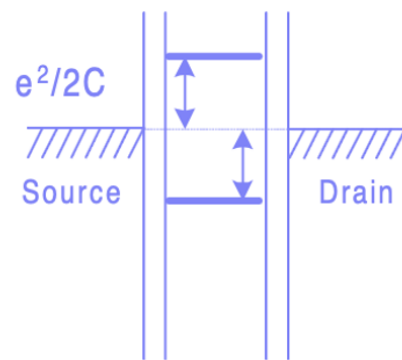
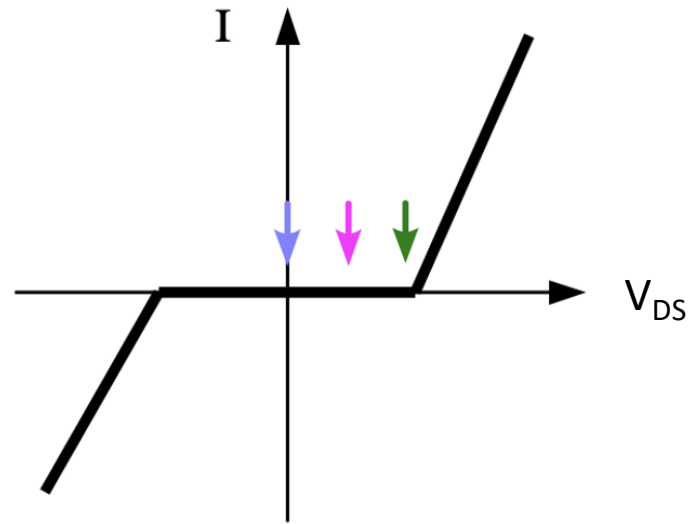



9.2 Quantum dot: Single electron transistor

Sketch the energy diagram of the quantum dot in the situations corresponding to the arrows

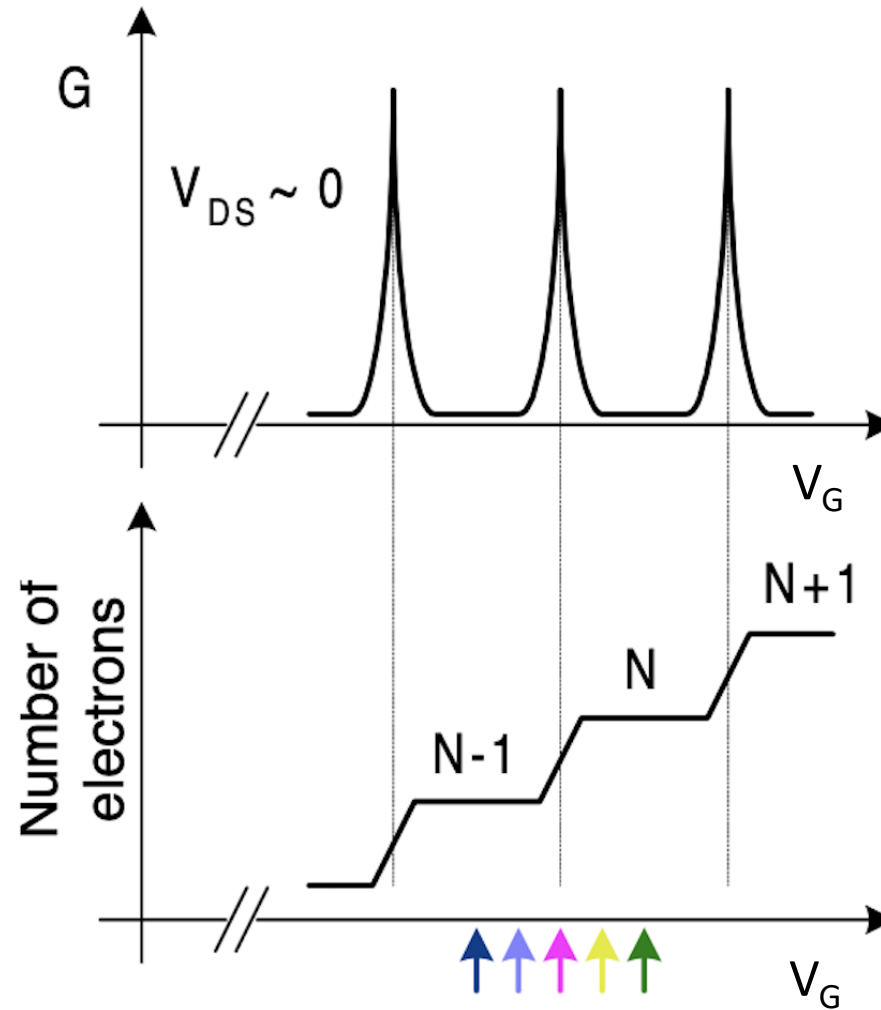
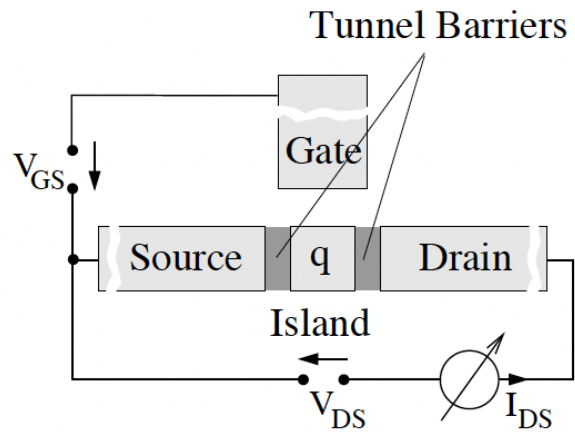



9.2 Quantum dot: Single electron transistor - Solution

