

Hydropower

Author: Stefano
Moret/Tuong-Van
Nguyen

Lecturer: Prof.
François Maréchal
EPFL – IPESE

Lausanne – 04/11/2019

Outline

- Introduction
 - Hydro today and future potential
 - Types of power stations

- Physics of hydro
 - Key equations: energy balance
 - Buckingham π theorem: similarity

- Hydraulic turbines
 - Hydraulic turbines: Pelton, Francis, Kaplan
 - New developments: microturbines

- Hydro & energy systems
 - Integration in the energy system

- Take home message



Introduction

Introduction

What is hydropower?

- Water covers 71% of the Earth surface, mostly (>95%) concentrated in oceans. → the water cycle.

- Used since early history:
 - Water wheels for irrigation
 - Water mills
 - Barbegal, 260 AD:
 - 10km long aqueduct
 - 18m head
 - 53 kW

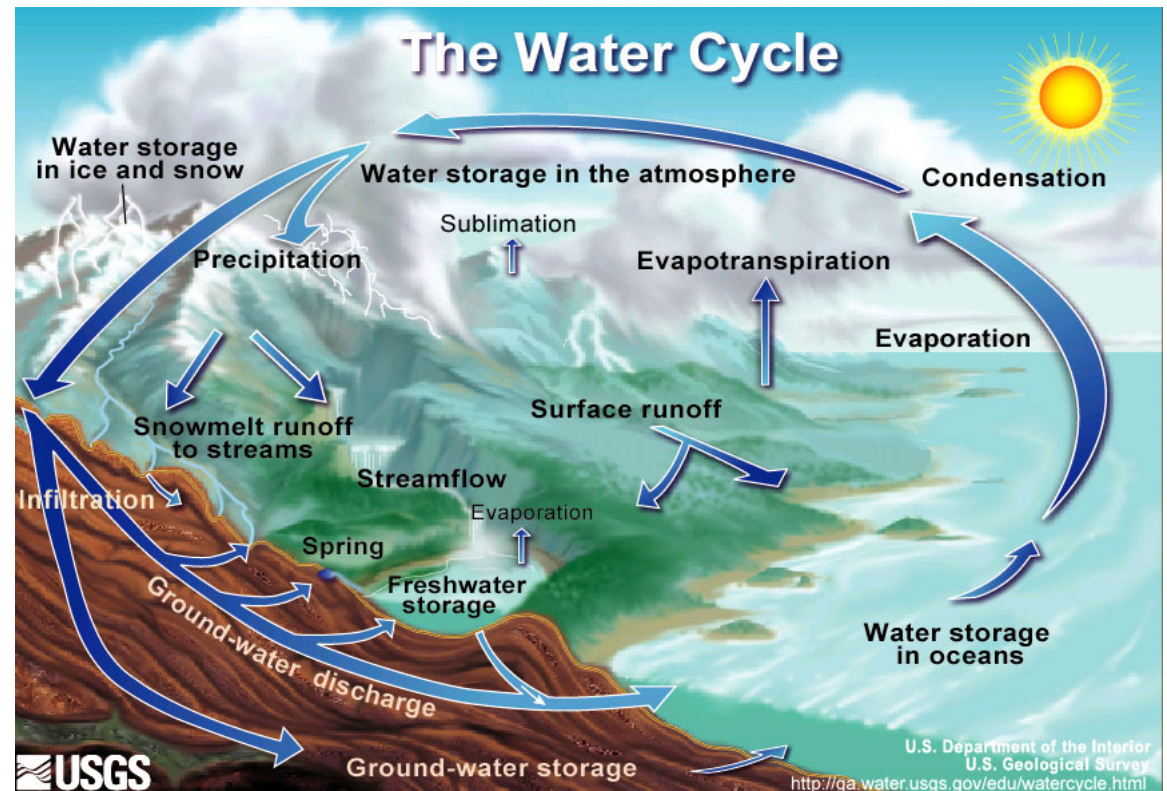

Introduction

Types of power stations

Hydro run-of-river



Hydro dam (storage)



Pumped storage

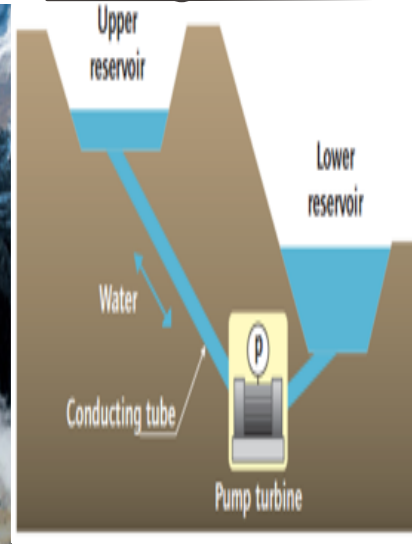

Introduction

What is hydropower?

- World final energy consumption: 109100 TWh/y (2015)
- World electricity production: 24255 TWh/y (2015)
- Hydro electricity production: 3978 TWh/y (2015)
- Most developed and mature renewable technology

World hydro electricity production¹ from 1971 to 2015 by region (TWh)

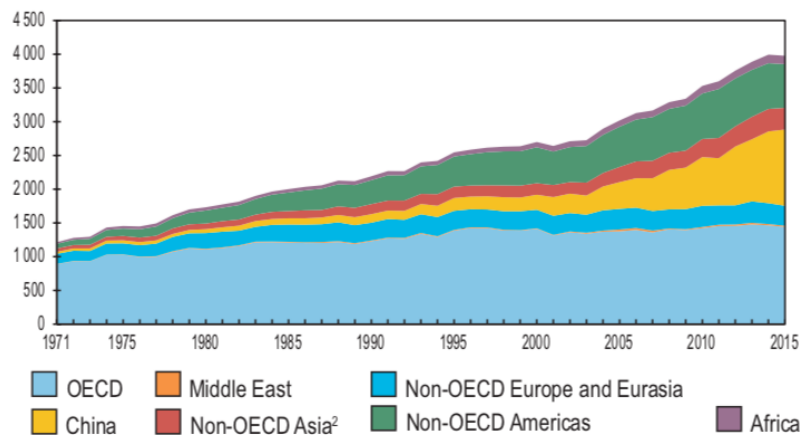

Electricity 2015

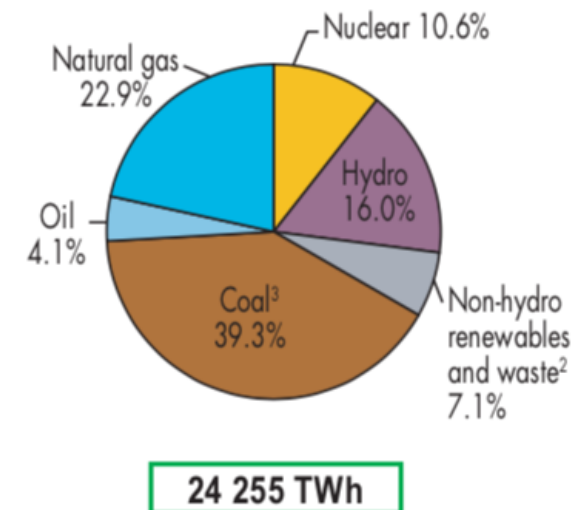

Introduction

Hydro today : World

- World final energy consumption: 109100 TWh/y (2015)
- World electricity production: 24255 TWh/y (2015)
- Potential (from table below): 30 EJ/y → 8300 TWh/y
- IEA technical potential: 15000 TWh/y

Table 7.28 | Estimates of world hydropower potential.

Estimation method	Comments	Hydropotential [EJ/yr]
Energy in the water cycle (Tester et al., 2005)	40,000 TW of instant solar power serving to evaporate water 40% of the time	504,000
Theoretical potential (Lehner et al., 2001)	For most rivers: mass of runoff × gravitational acceleration × height	200
Maximum technical potential, based on rivers and or sites ^a	Technical potential of known sites, assuming a very high use factor	140–145
Technical potential, based on sites at 2–20¢ per kWh ^b	Portion of technical potential, with a realistic use factor, that is sufficiently promising to justify a site assessment	50–60
Economical potential, based on sites at 2–8¢ per kWh ^c	Portion of technical potential, with a realistic use factor, that is competitive with large thermal power plants	30

Introduction

Hydro today : Europe

- Hydro capacity relatively stable
- ENTSO-E hydro electricity: 562.8 TWh/y (2017) → 15.3%
- ENTSO-E hydro capacity: 212.4 GW (2017) → 18.4%

ENTSO-E renewable generation¹

	year	TWh	%
Renewable net generation	2015	1042.4	
	2016	1200.0	
	2017	1228.1	
of which hydro	2015	489.2	47
	2016	604.6	50
	2017	562.8	46
of which wind	2015	310.6	30
	2016	316.1	26
	2017	370.8	30
of which biomass	2015	116.2	11
	2016	136.1	11
	2017	141.1	11
of which solar	2015	102.0	10
	2016	105.0	9
	2017	114.3	9
of which other renewable	2015	24.5	2
	2016	38.3	3
	2017	39.3	3

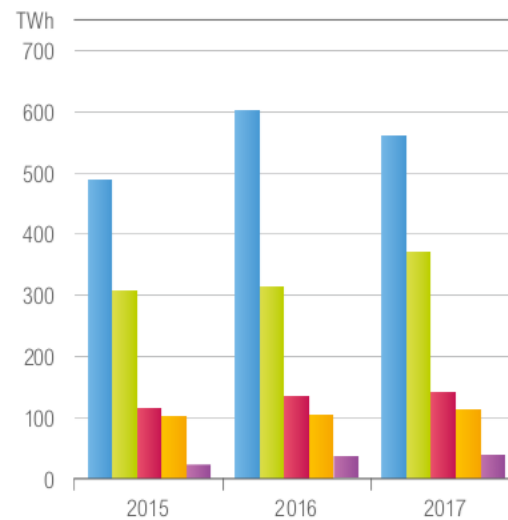

Introduction

Hydro today : CH

- Swiss final energy consumption: 236 TWh/y (2017)
- Swiss electricity production: $61.5 \text{ TWh}_e/\text{y} - 4.16 \text{ TWh}_e/\text{y} \text{ (pumping)} = 57.3 \text{ TWh}_e/\text{y}$ net (2017)
- Of which hydro:
 - Dams: 20.72 TWh/y in 2017; 8.1 GW
 - Rivers: 15.95 TWh/y in 2017; 3.8 GW
 - ~60% of Swiss gross electricity production

Fig. 10 Monatliche Erzeugungsanteile und Landesverbrauch im Kalenderjahr 2017
Quotes-parts mensuelles et consommation du pays durant l'année civile 2017

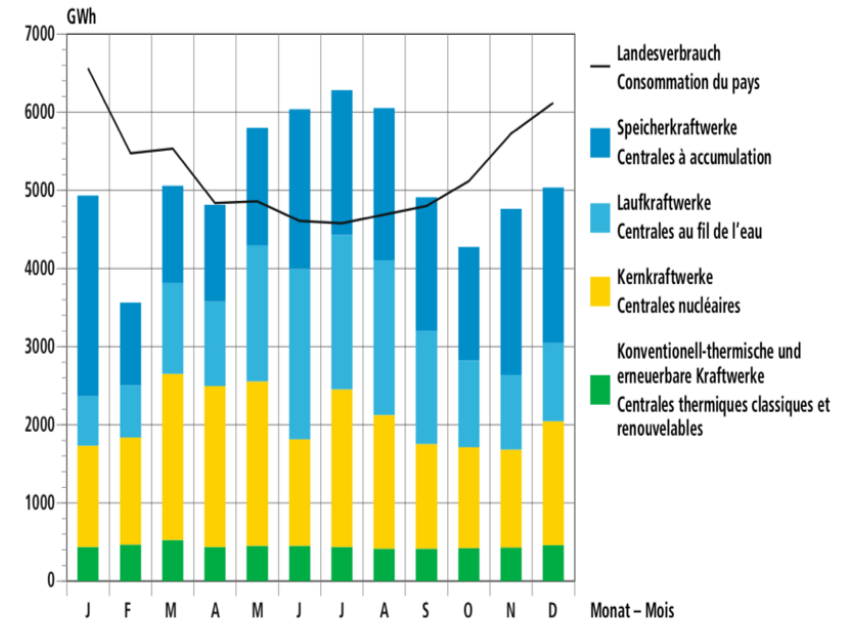

BFE, Schweizerische Elektrizitätsstatistik 2017 (Fig. 10)
OFEN, Statistique suisse de l'électricité 2017 (fig. 10)

EPFL Role of Hydro Power in the electricity in CH : following the demand

Fig. 17 Belastungsverlauf am 3. Mittwoch des Monats: Erzeugung (oben), Verbrauch (unten)
Diagramme de la puissance/charge le 3^e mercredi du mois: production (en haut), conso

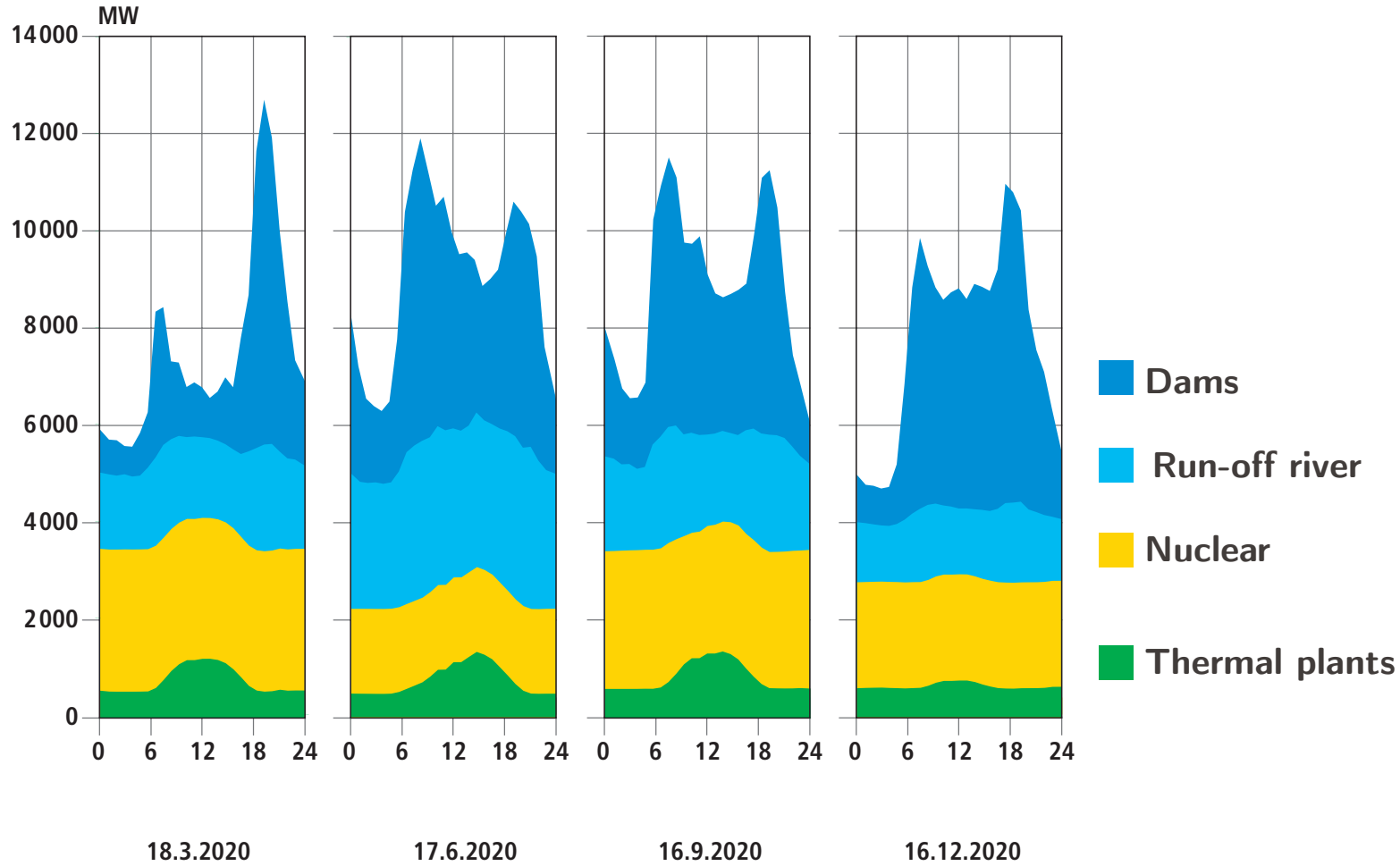

EPFL Role of Hydro Power in the electricity in CH : following the market

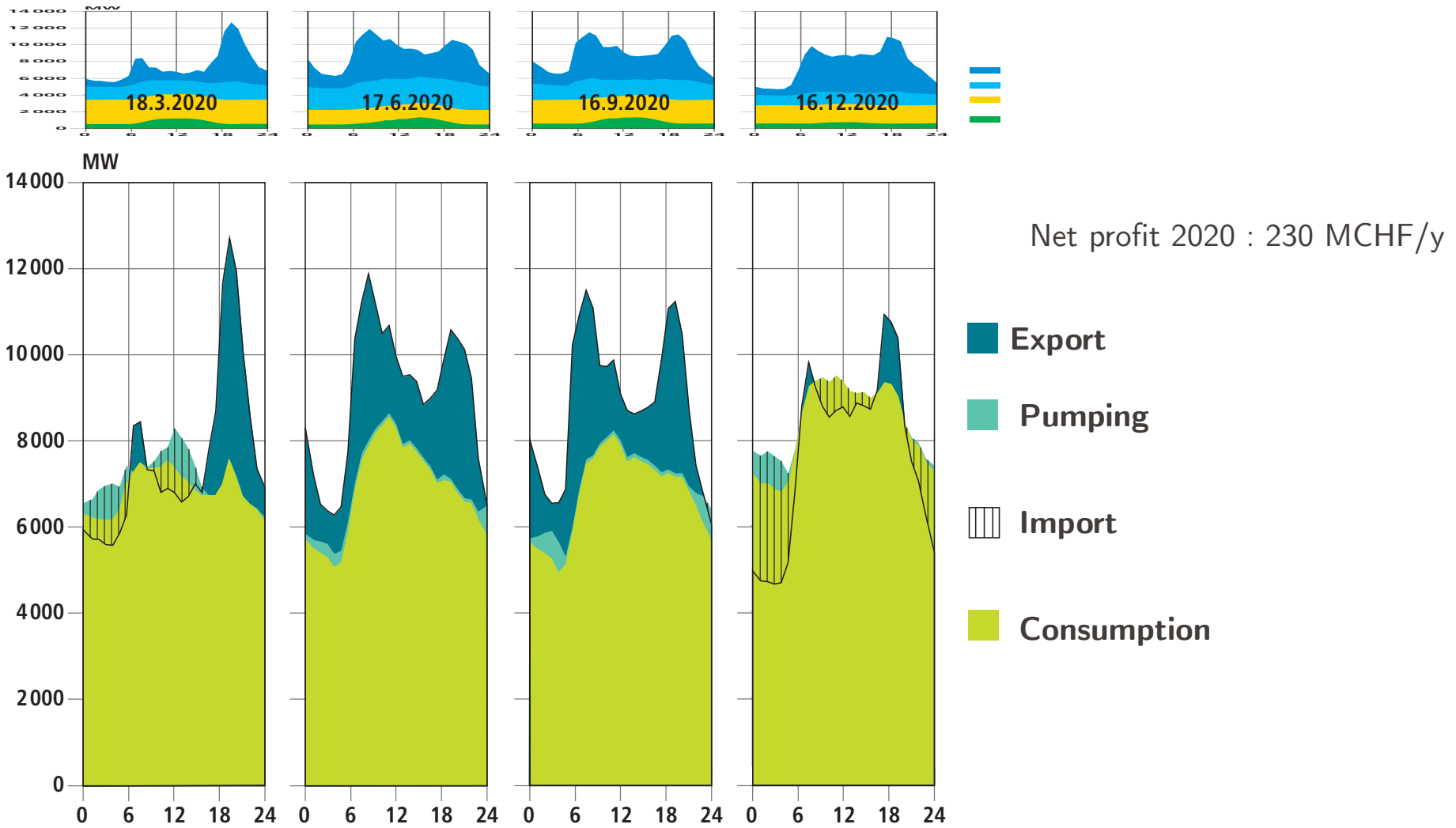



Physics of hydro

Physics of hydro

Key equations

- Low energy density resource:

- Water @ 100m height: 0.001 MJ/kg
- Natural gas: 45-50 MJ/kg

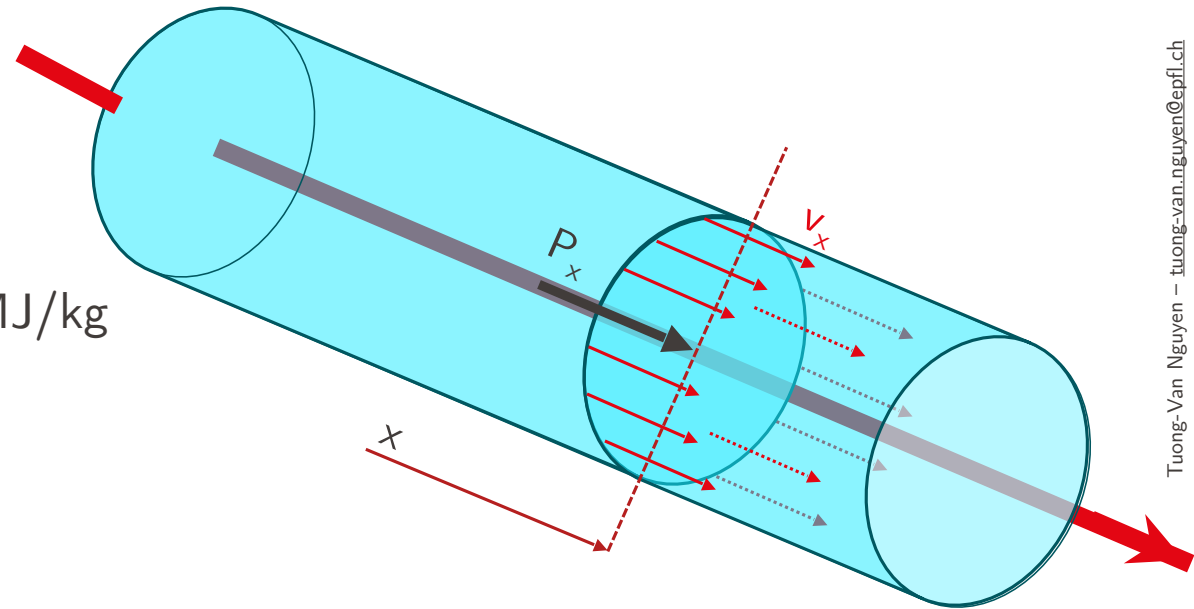

- Basic equations for a water flow:

- Bernoulli at $x \rightarrow$ specific enthalpy [J/kg]
$$gH_x = gz_x + \frac{P_x}{\rho} + \frac{v_x^2}{2}$$
- Discharge (flow rate) [m³/s]:
$$Q = \int_A \vec{v} \cdot \vec{n} dA = v_x A$$
- Power [W]:
$$\dot{E} = \rho v_x A g H_x$$

Physics of hydro

Energy balance

- Schematics of a power station:
 - z_U : level of the upper reservoir [m]
 - z_L : level of the lower reservoir [m]
 - 1: entry of the turbine
 - 2: exit of the turbine

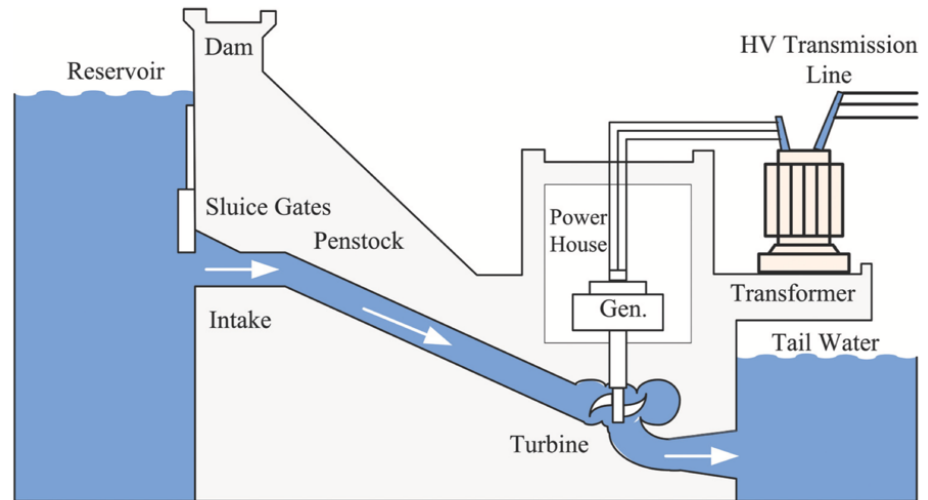

1. High energy side (head water):

$$gH_U = \frac{P_{atm}}{\rho} + gz_U + 0 = gH_1 + \sum_{\text{Head side}} gH_r$$

2. Low energy side (tail water):

$$gH_L = \frac{P_{atm}}{\rho} + gz_L + 0 = gH_2 + \sum_{\text{Tail side}} gH_r$$

Physics of hydro

Energy balance

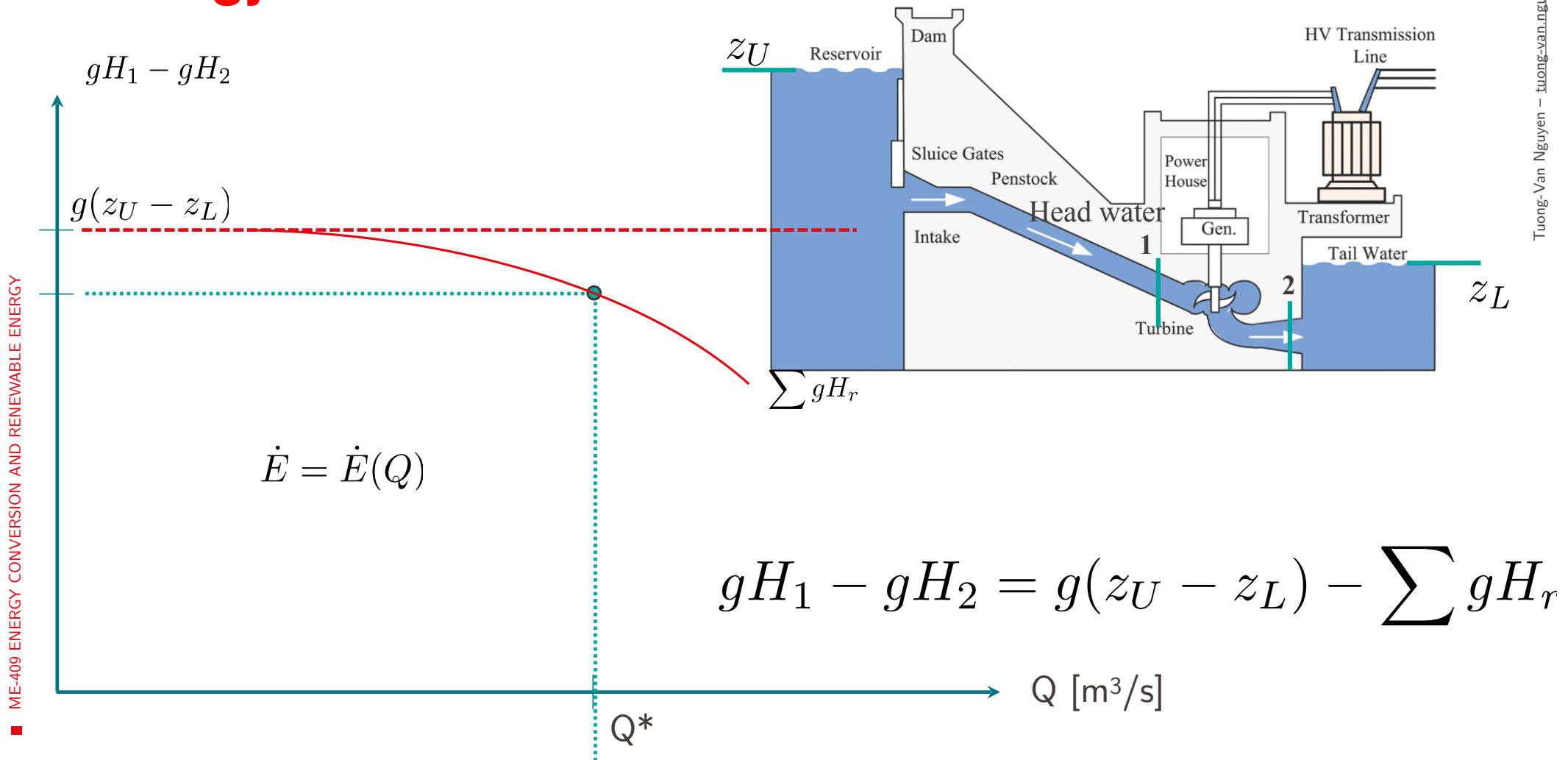

Physics of hydro

Energy balance

- At the turbine:

$$e_{12} = gH_1 - gH_2 = g(z_U - z_L) - \sum gH_r$$

$$= \underbrace{\left(gz_1 + \frac{P_1}{\rho} \right) - \left(gz_2 + \frac{P_2}{\rho} \right)}_{e_p \text{ potential}} + \underbrace{\frac{1}{2}(v_1^2 - v_2^2)}_{e_k \text{ kinetic}} - e_{loss}$$

- Degree of reaction: $\tau_r = \frac{e_p}{e_{12}}$

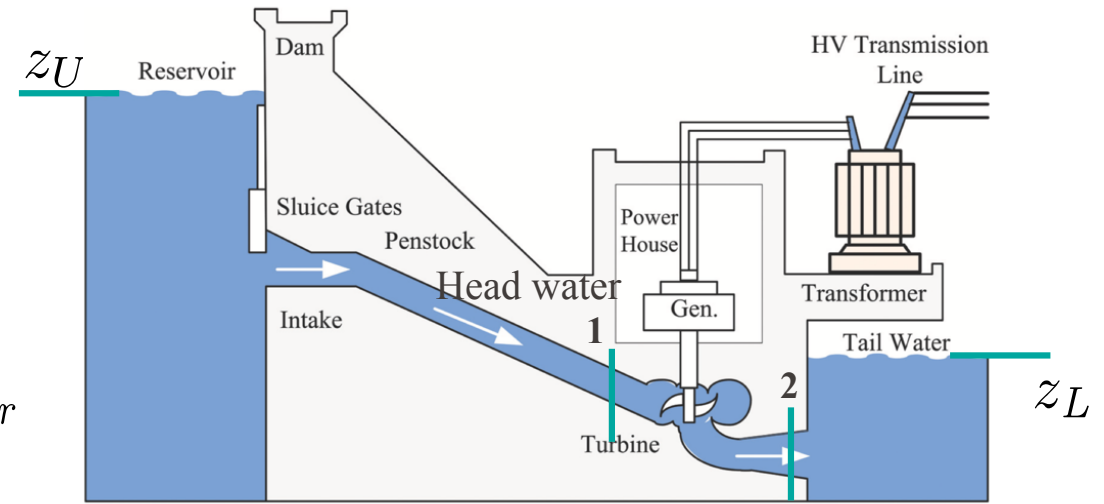

Physics of hydro

Buckingham theorem

- “if there is a physically meaningful equation involving a certain number n of physical variables, then the original equation can be rewritten in terms of a set of $p = n - k$ **dimensionless** parameters $\pi_1, \pi_2, \dots, \pi_p$ constructed from the original variables [$k = \#$ independent dimensions.]”
 - e.g. for t (time), d (distance), v (speed): $n = 3$; $k = 2$ ([m], [s]); $p = 1 \rightarrow \pi = t*v/d$.
- Dimensionless quantities are fundamental in engineering as they allow studying systems in lower scales \rightarrow **similarity**
- The **specific speed** is a dimensionless quantity which summarizes the essential characteristics of a water turbine:

$$v = \frac{\omega Q^{\frac{1}{2}}}{\pi^{\frac{1}{2}} (2e)^{\frac{3}{4}}}$$

Angular speed [rad/s] \leftarrow

Discharge [m³/s] \nearrow

Specific energy available at the turbine [J/kg] \rightarrow depends on the head [m]

Physics of hydro

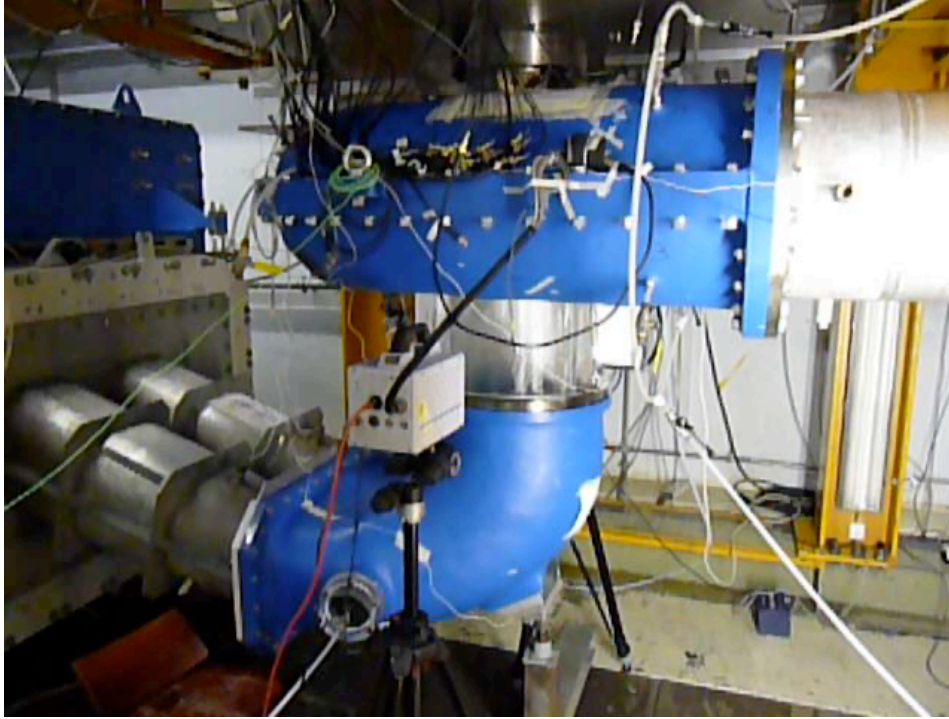



Hydraulic turbines

Hydraulic turbines

Classification

$$e_{12} = \underbrace{\left(\frac{P_1}{\rho} - \frac{P_2}{\rho} \right)}_{\text{displacement}} + \underbrace{\frac{1}{2}(v_1^2 - v_2^2)}_{\text{impulse}} + \underbrace{g(z_1 - z_2)}_{\text{water wheels}} - e_{loss}$$

reaction e_p

Reaction level :

$$\tau_r = \frac{e_p}{e_{12}}$$

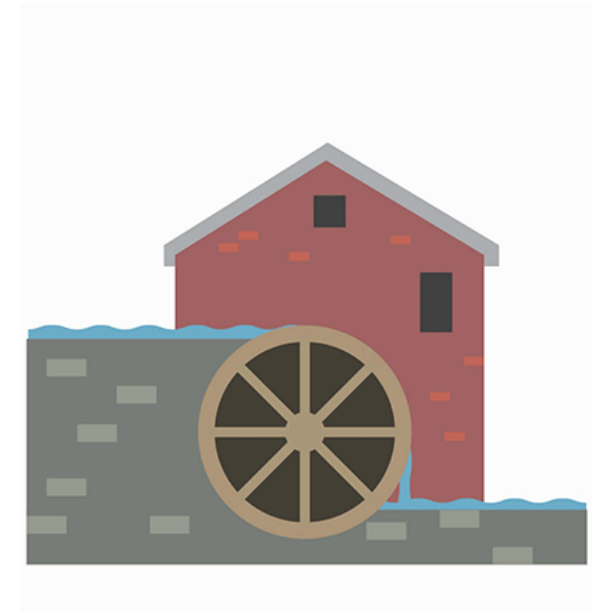

Hydraulic turbines Classification

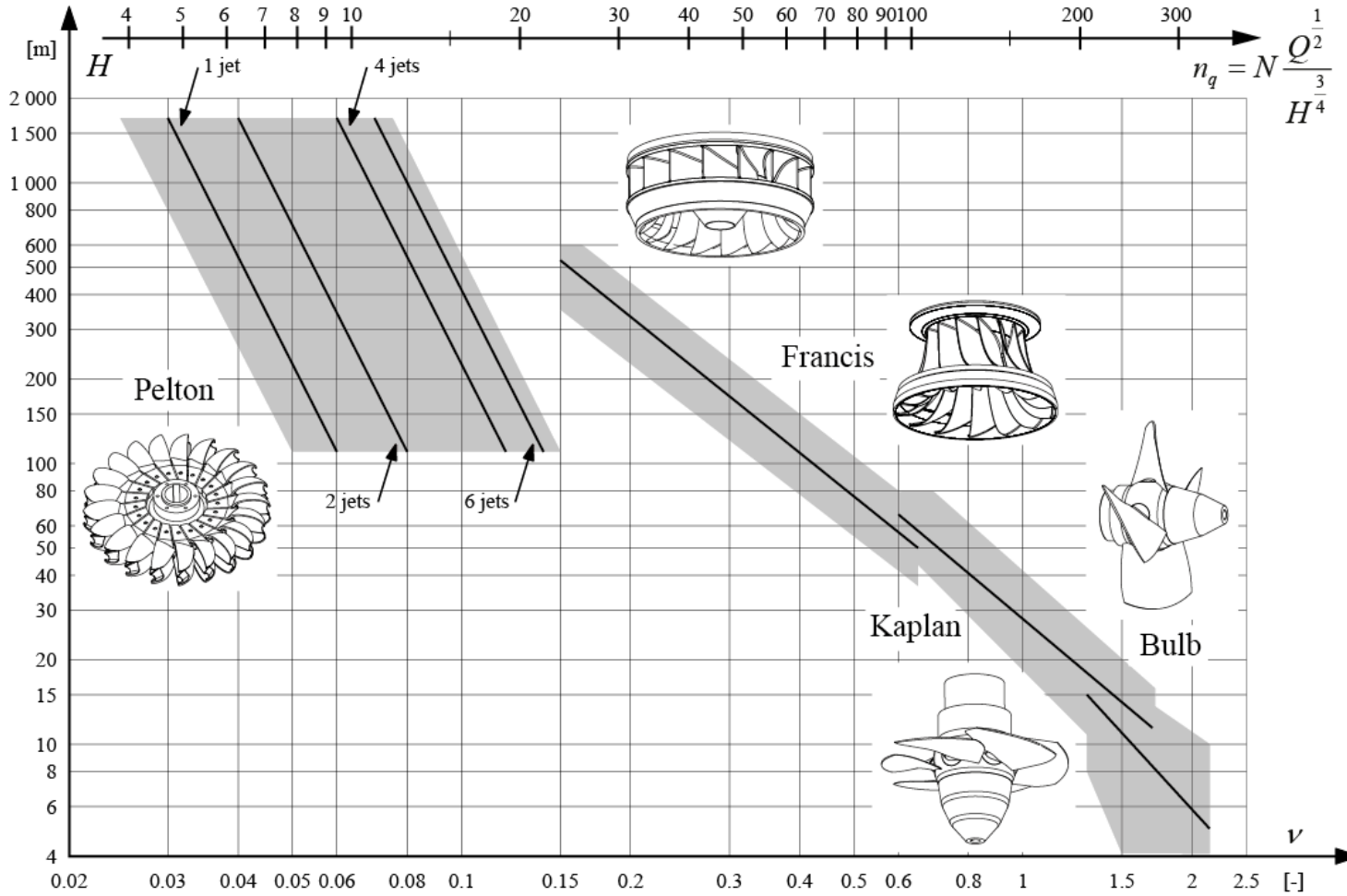

Hydraulic turbines

Classification Pelton turbines

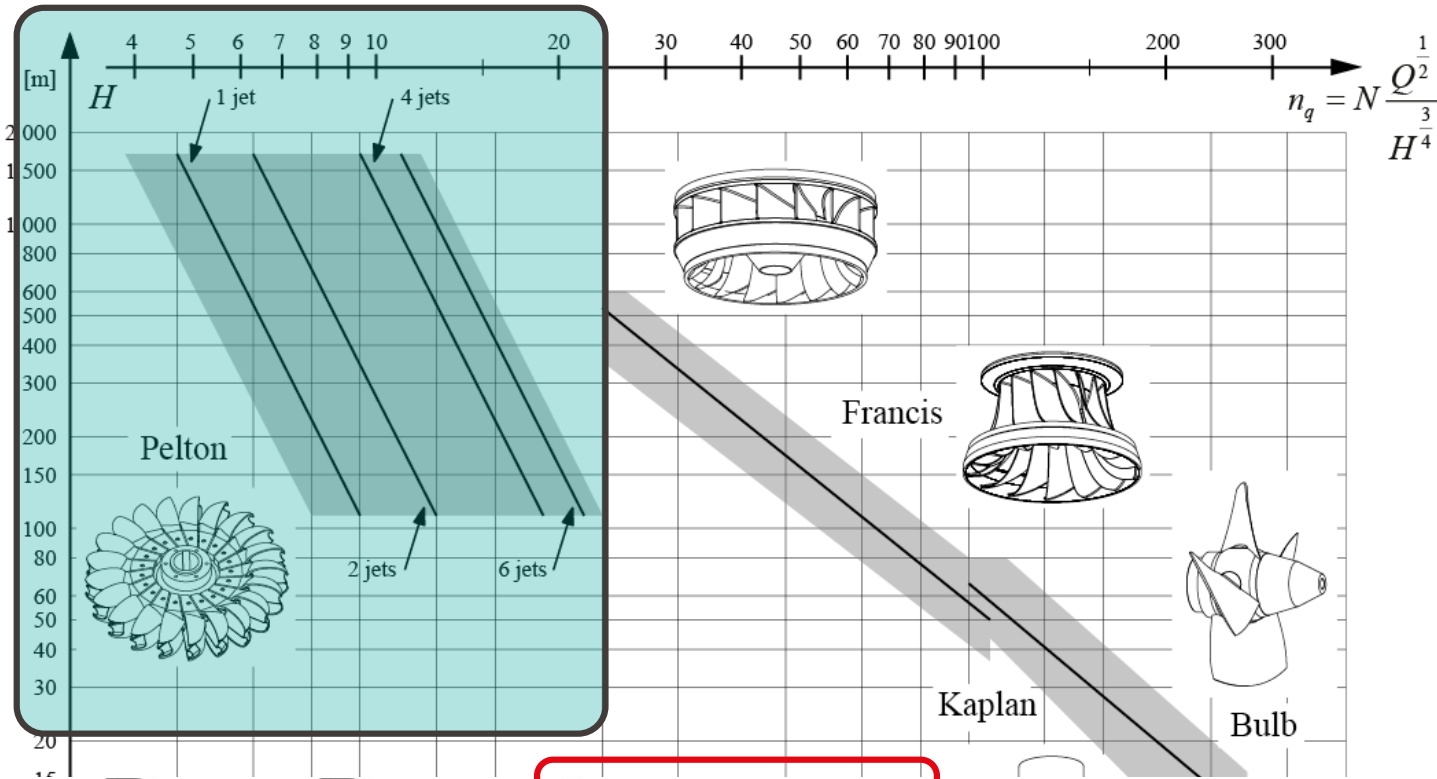

$$e_{12} = \left(\frac{P_1}{\rho} - \frac{P_2}{\rho} \right) + \frac{1}{2} (v_1^2 - v_2^2) + g(z_1 - z_2) - e_{loss}$$

0.02 0.03 0.04 0.05 0.06 0.08 0.1 0.15 0.2 0.3 0.4 0.5 0.6 0.8 1 1.5 2 2.5 [-]

Hydraulic turbine

Pelton

- High head, low discharge
- Impulse/action turbine (only speed)
- Head: 300-2000m
- Power up to $\sim 400 \text{ MW}_e$
- Efficiency up to 92%

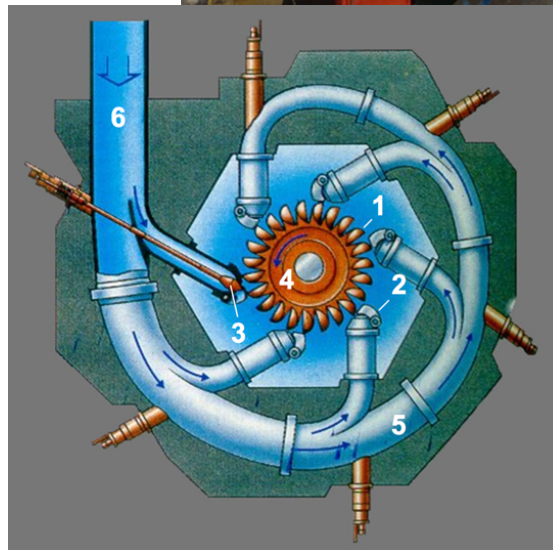

Hydraulic turbines

Classification : Francis turbines

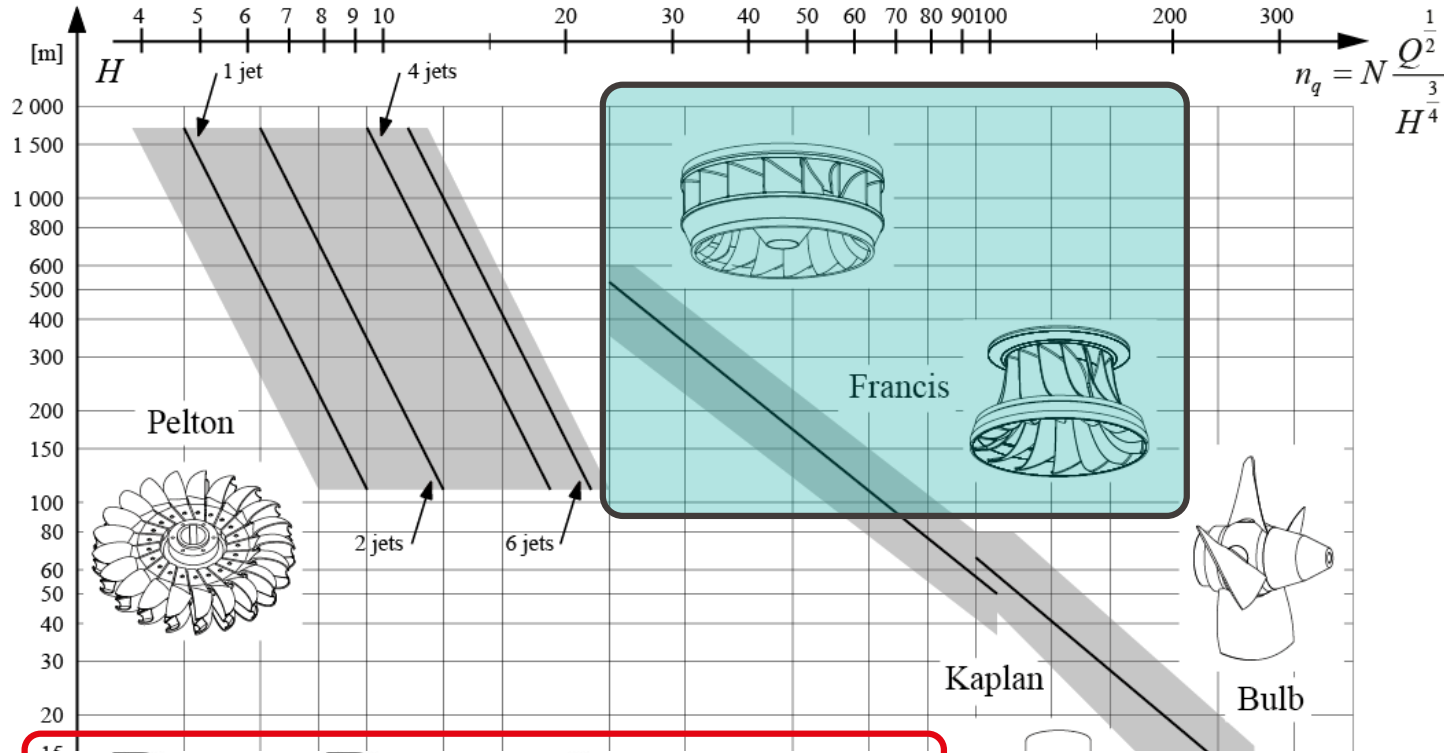

$$e_{12} = \left(\frac{P_1}{\rho} - \frac{P_2}{\rho} \right) + \frac{1}{2} (v_1^2 - v_2^2) + g(z_1 - z_2) - e_{loss}$$

0.02 0.03 0.04 0.05 0.06 0.08 0.1 0.15 0.2 0.3 0.4 0.5 0.6 0.8 1 1.5 2 2.5 [-]

Hydraulic turbines

Francis

- Most used and versatile turbine:
~60% of capacity worldwide
- Reaction turbine
- Medium heads: 40-600m
- Wheel diameters: 0.6-8m
- High efficiency: 96-97%
- Three Gorges dam (China):
Biggest power plant worldwide
Total capacity: 22.5 GW_e
- Itaipu (Brazil):
20*700 MW = 14 GW
103.1 TWh/y (record 2016)



Hydraulic turbines

Francis

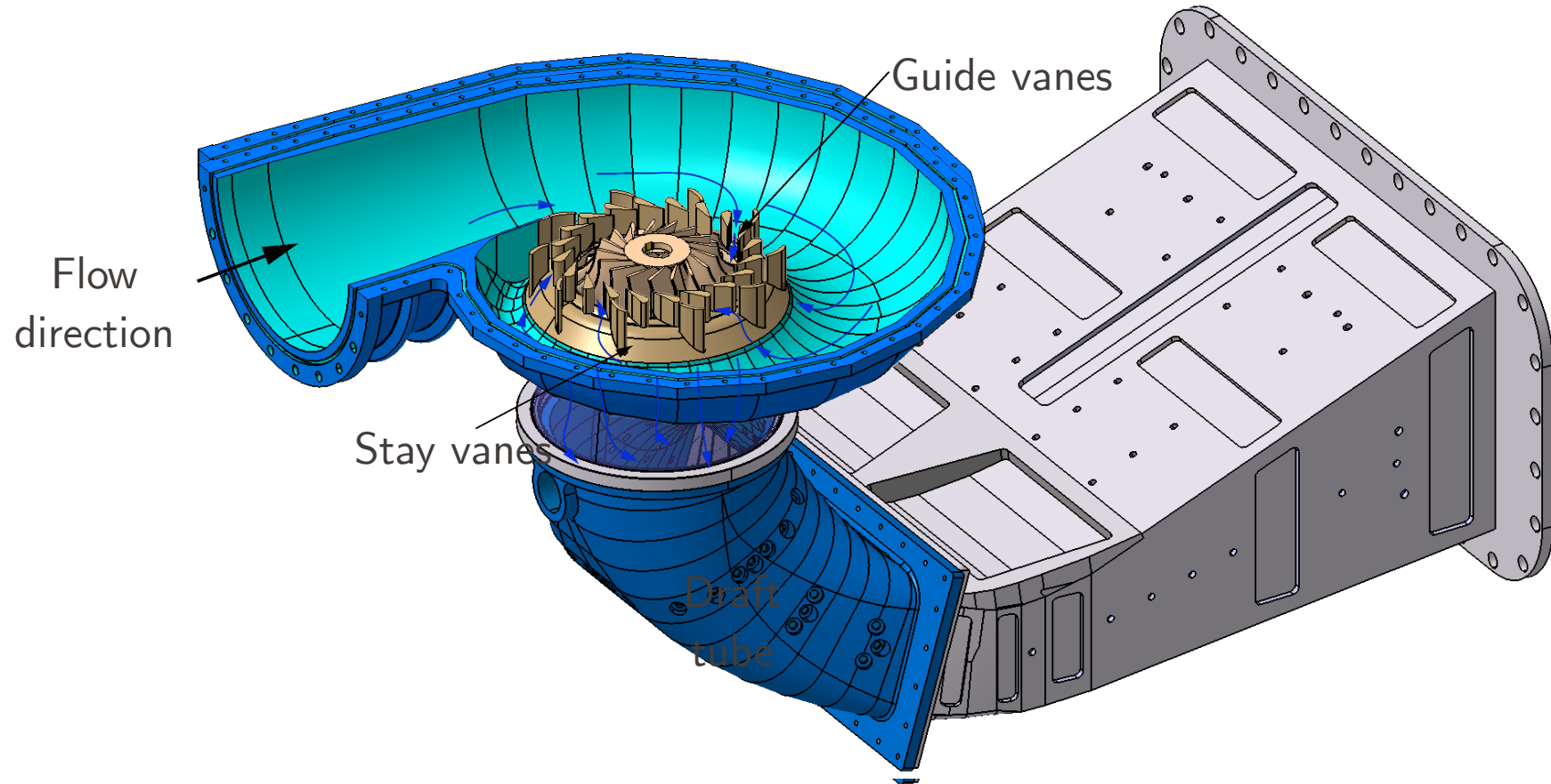

Hydraulic turbines

Classification Kaplan and Bulb turbines

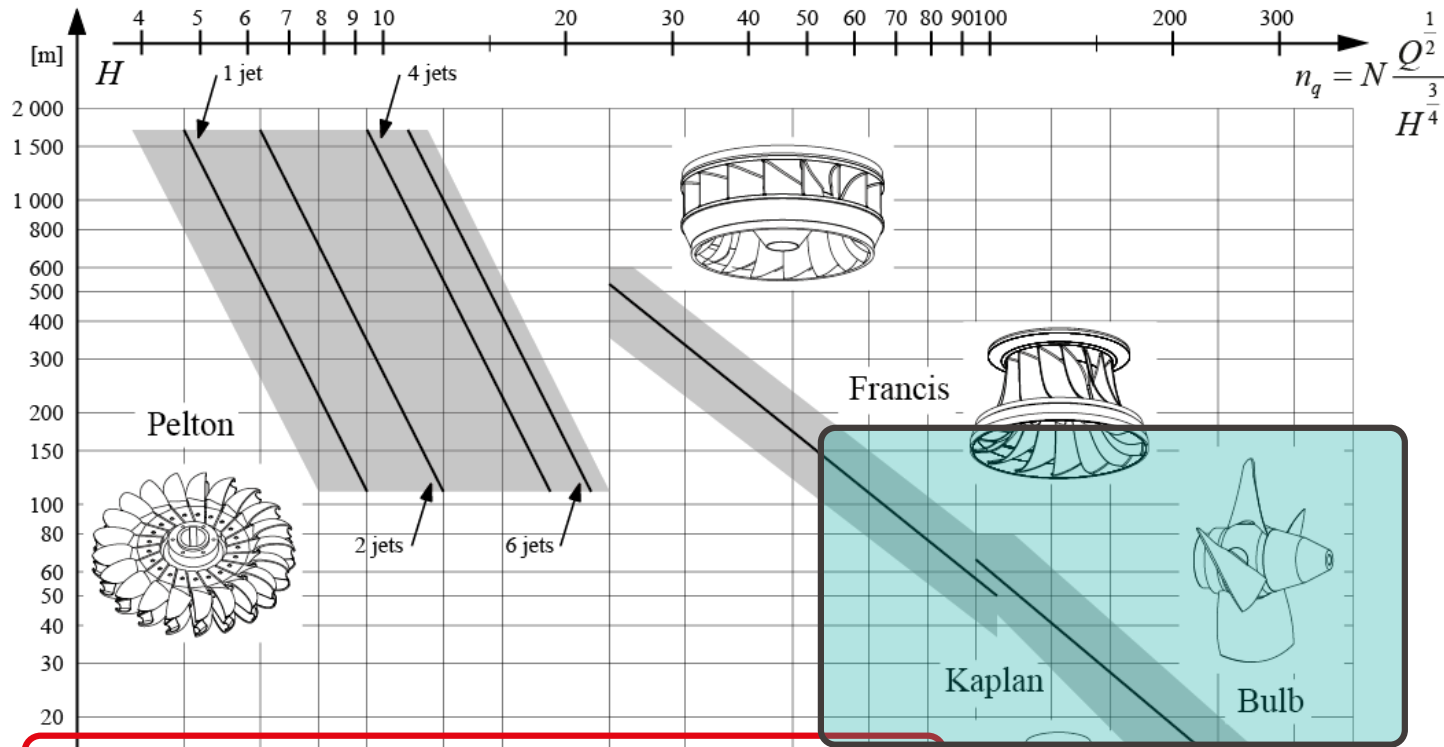

$$e_{12} = \left(\frac{P_1}{\rho} - \frac{P_2}{\rho} \right) + \frac{1}{2} (v_1^2 - v_2^2) + g(z_1 - z_2) - e_{loss}$$

0.02 0.03 0.04 0.05 0.06 0.08 0.1 0.15 0.2 0.3 0.4 0.5 0.6 0.8 1 1.5 2 2.5 [-]

Hydraulic turbines

Kaplan

- V. Kaplan (1913), evolution of Francis for low heads
- Axial flow
- High degree of reaction
- Run-of-river plants
- Low head (10-70m), high discharge
- Typical power: 5-200 MW_e
- Problem: cavitation

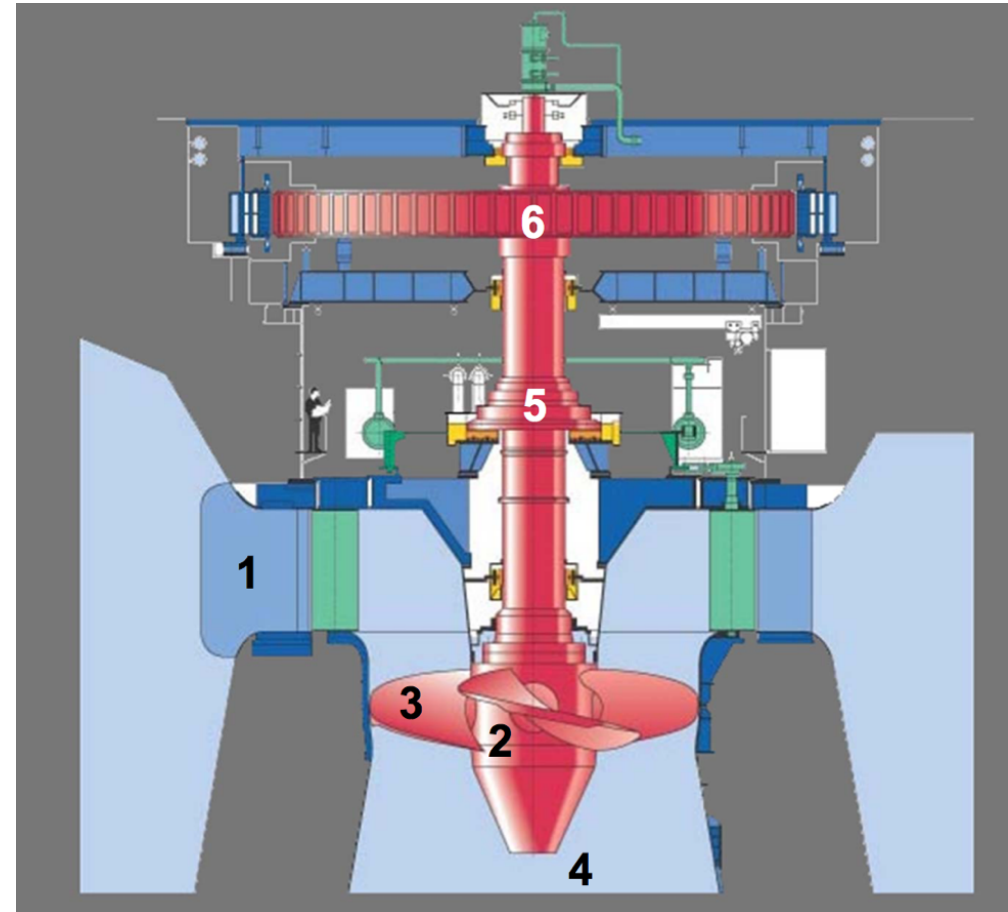

Hydraulic turbines

Bulb

- 1930s: evolution of the Kaplan turbine
- Axial flow → higher efficiencies
- Compact design
- Lower costs

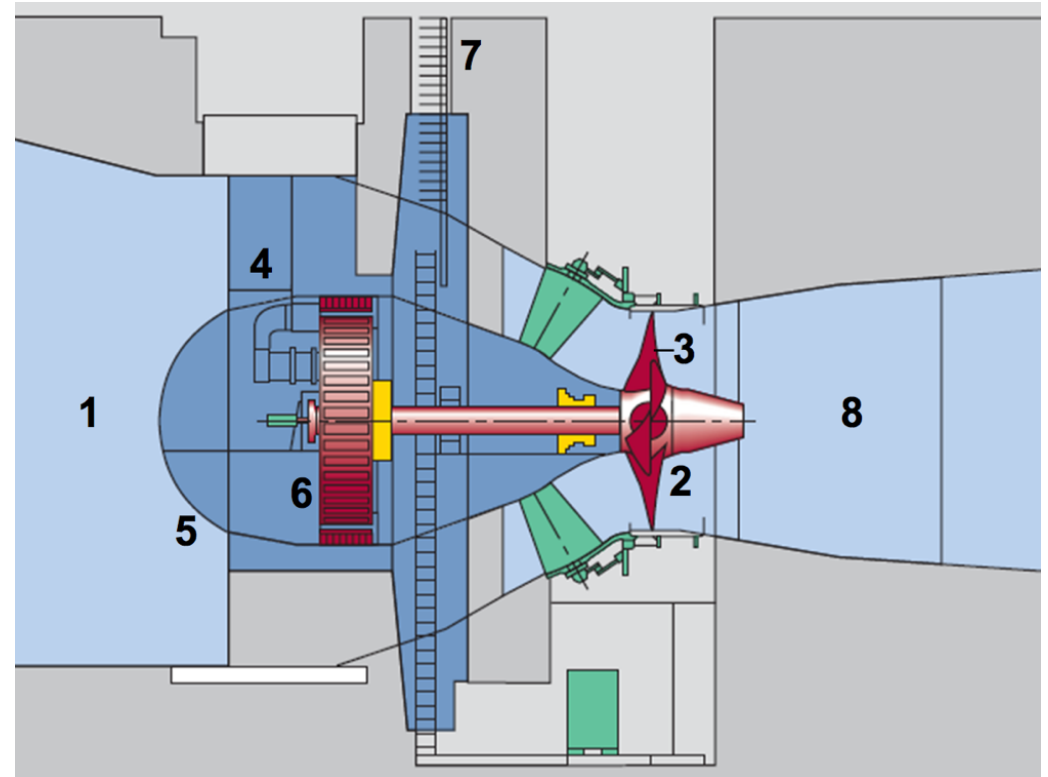

Efficiency of turbine

$$\dot{E} = \dot{m} \cdot w_{12} \cdot \eta_T \cdot \eta_{gen} \cdot \eta_{gear} \cdot \eta_{transfo}$$

$\eta_T = 92\%$ Mechanical efficiency of the turbine

$\eta_{gear} = 98\%$ Efficiency of the gear box

$\eta_{gen} = 97\%$ Efficiency of the generator

$\eta_{transfo} = 98\%$ Efficiency of the transformer

$\eta_{total} = 86\%$ Overall efficiency to grid

■



Hydro and energy systems

Hydro and energy systems

Hydroelectric schemes

- Storage and run-of-river power plants

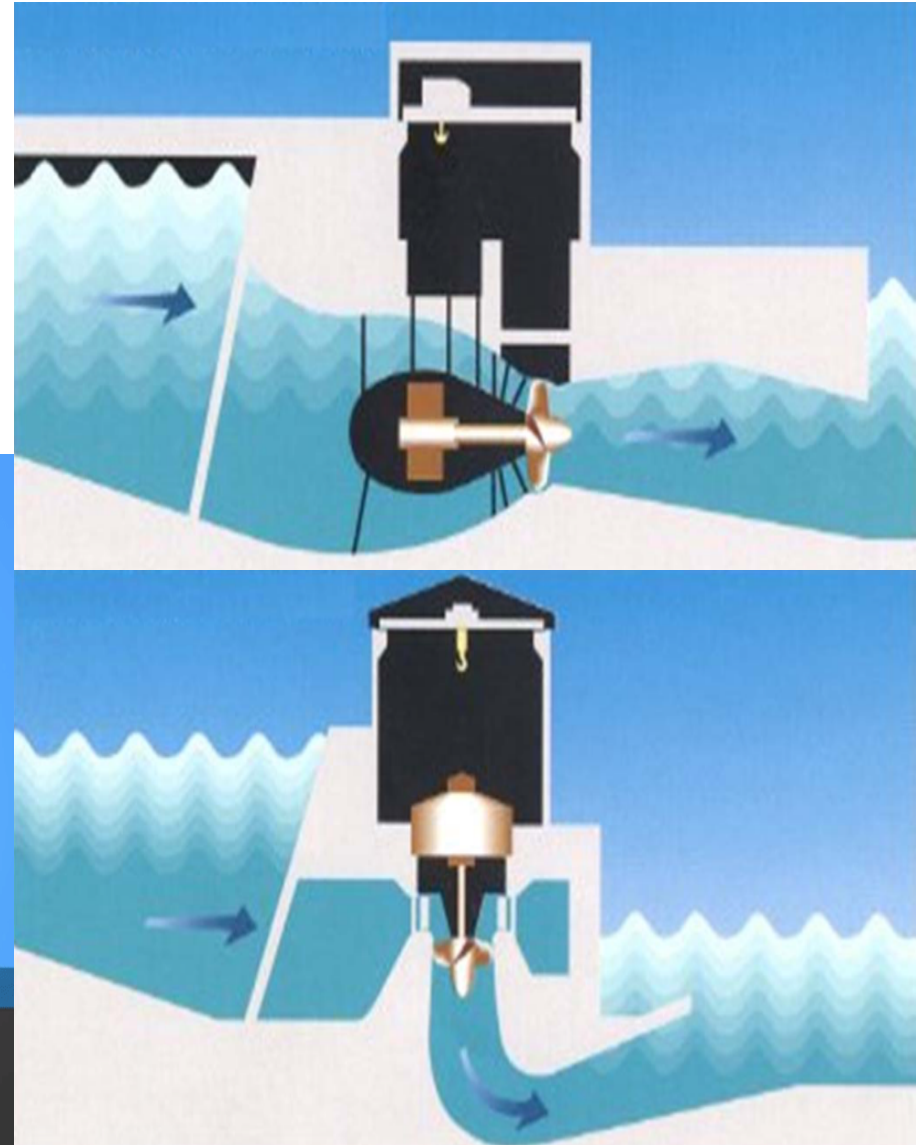
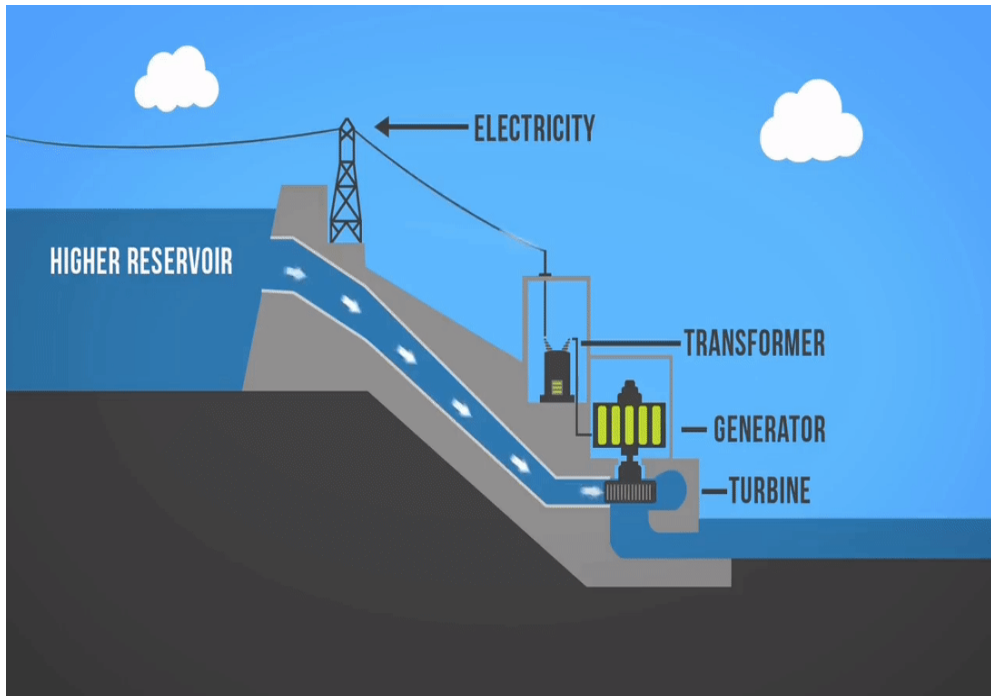

Hydro and energy systems

Costs

- Costs are quite project specific: 1050-7650 USD/kW_e for large projects
- LCOE @ $c_p = 50\%$: 28-90 USD/MWh_e → very competitive!

LCOE (USD/MWh)	Weighted average capital cost or discount rate			
		8%	10%	12%
	25%	90	110	133
Load factor	50%	41	51	61
	75%	28	34	41

LCOE assuming 1500 USD/kW, O&M 2.5% of c_{inv} , 5y construction, 50y lifetime

Hydro and energy systems

Costs

- Costs are quite project specific: 1050-7650 USD/kW_e for large projects
- LCOE @ $c_p = 50\%$: 28-90 USD/MWh_e → very competitive!

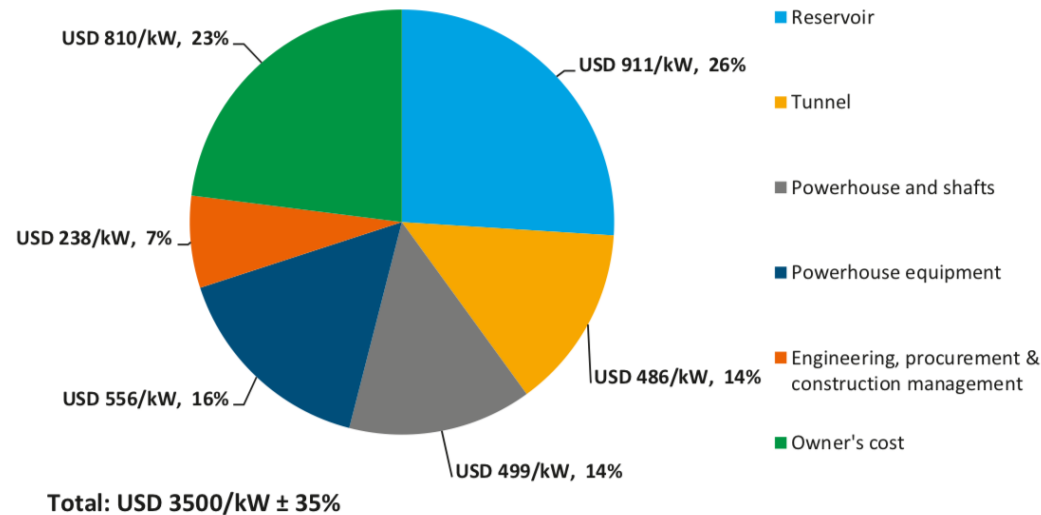

EPFL Impact of climate change

- Glaciers are losing 1 GT/year (2%) of ice (transformed in power)
- Temperatures will influence storage in snow and precipitation

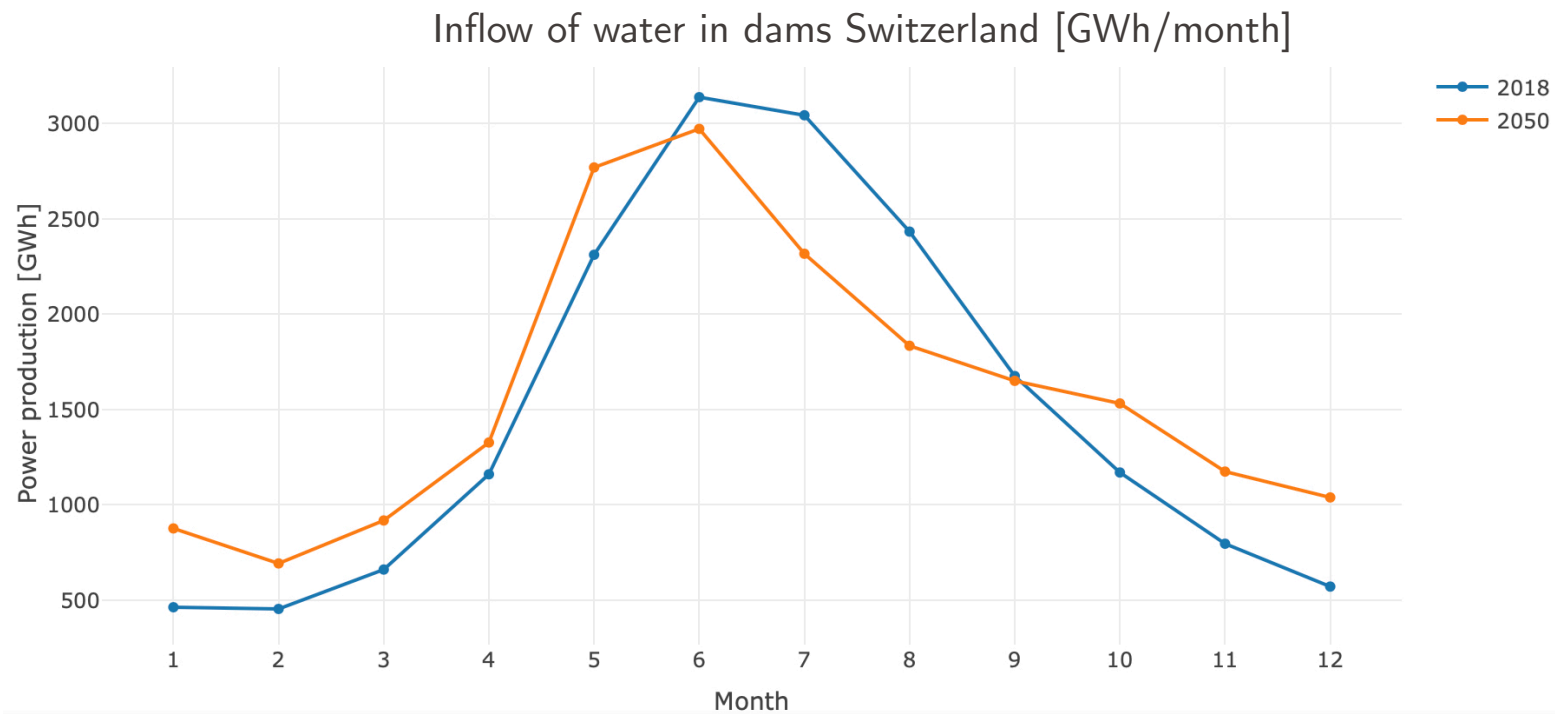

EPFL Pumped-hydro storage

Hydro-electric schemes

Pumped storage

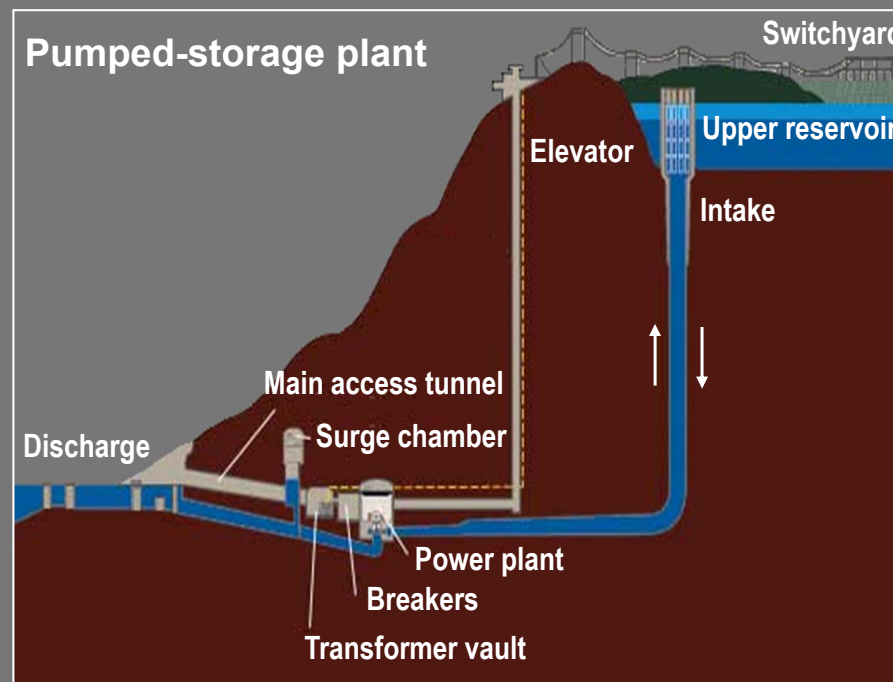
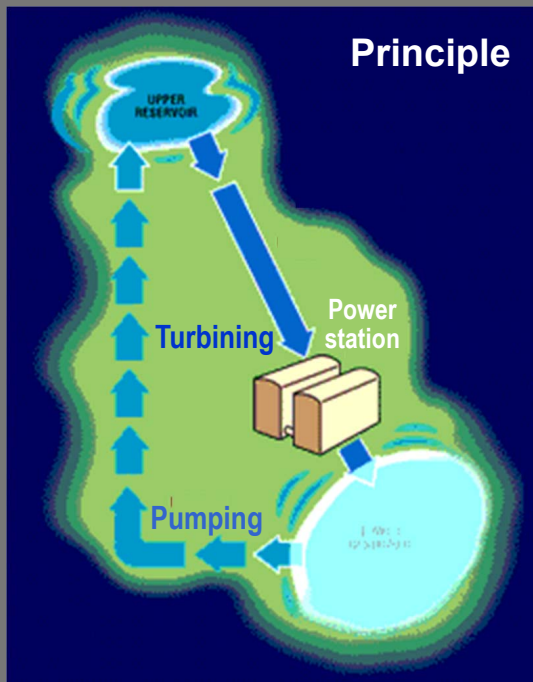

$$\eta_{RoundTrip} = \frac{E_{out}}{E_{in}}$$

Round trip efficiency = 80%





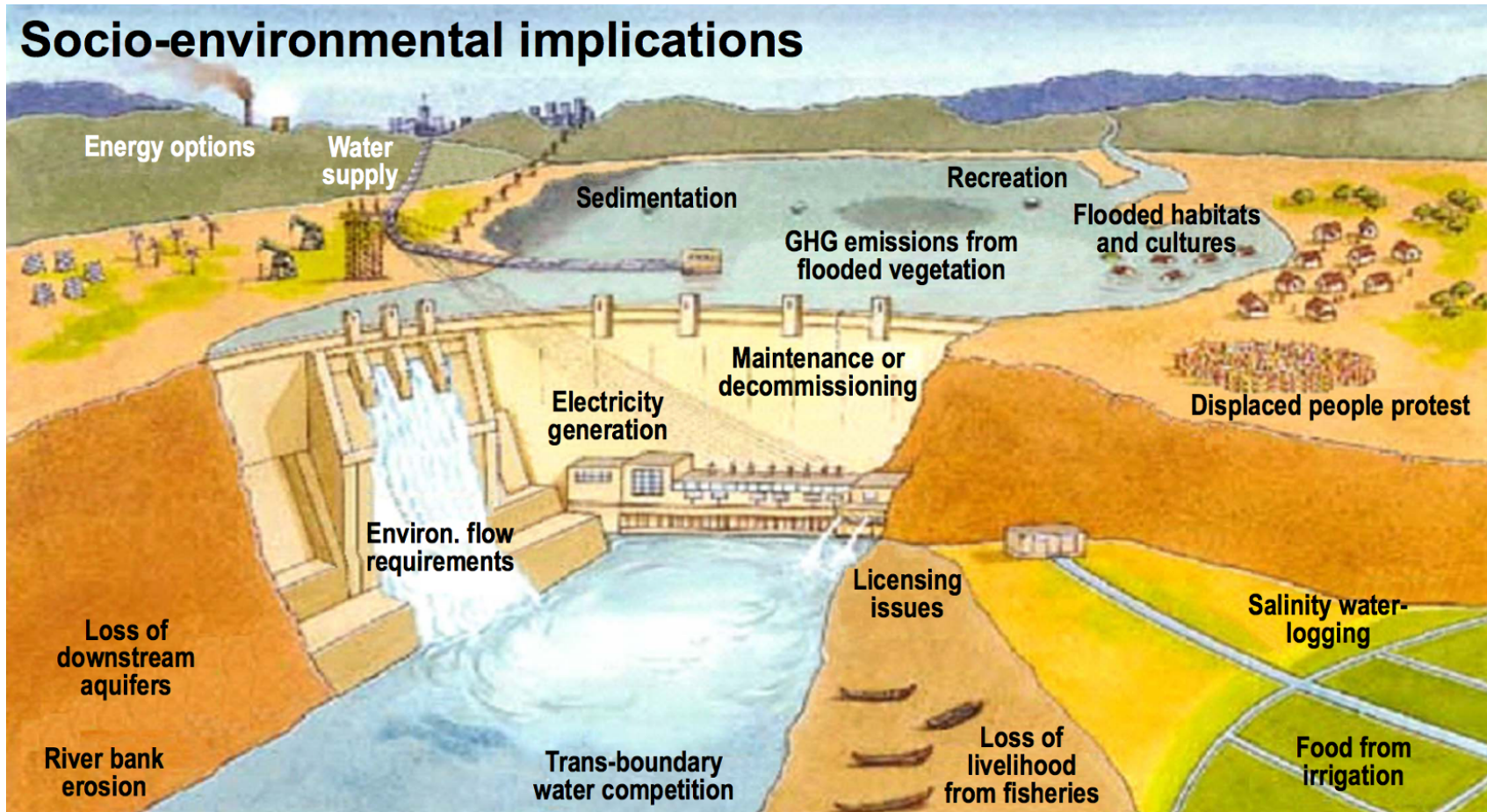











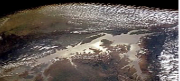

Hydro and energy systems

Impacts

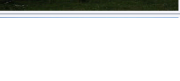

EPFL Hydro dams : land occupation & people displacement

- China : about 15 to 20 Million people relocated
- Land occupation source wikipedia

Name	Country	Dam	Outflow	Surface area		Ref	Image
				km ²	mi ²		
Lake Victoria ^[n 1]	 Kenya  Tanzania  Uganda	Owen Falls Dam	White Nile	66,400	25,600	[1]	
Irkutsk Reservoir– Lake Baikal ^[n 2]	 Russia	Irkutsk Dam	Angara River	32,000	12,000	[2]	
Lake Winnipeg ^[n 3]	 Canada	Jenpeg Dam	Nelson River	24,420	9,430	[3]	
Lake Volta	 Ghana	Akosombo Dam	Volta River	8,500	3,300	[4]	
Smallwood Reservoir	 Canada	Multiple	Churchill River	6,527	2,520	[5]	
Reindeer Lake ^[n 4]	 Canada	Whitesand Dam	Reindeer River	6,500	2,500	[6]	
Kuybyshev Reservoir	 Russia	Zhiguli Dam	Volga River	6,450	2,490		
Lake Kariba	 Zambia  Zimbabwe	Kariba Dam	Zambezi River	5,580	2,150	[7]	
Bukhtarma Reservoir ^[n 5]	 Kazakhstan	Bukhtarma Dam	Irtys River	5,490	2,120	[8]	
Bratsk Reservoir	 Russia	Bratsk Dam	Angara River	5,470	2,110	[9]	



Hydro and energy systems

Impacts

Figure 13: Estimates of lifecycle GHG emissions in electricity generation (excluding land-use changes)

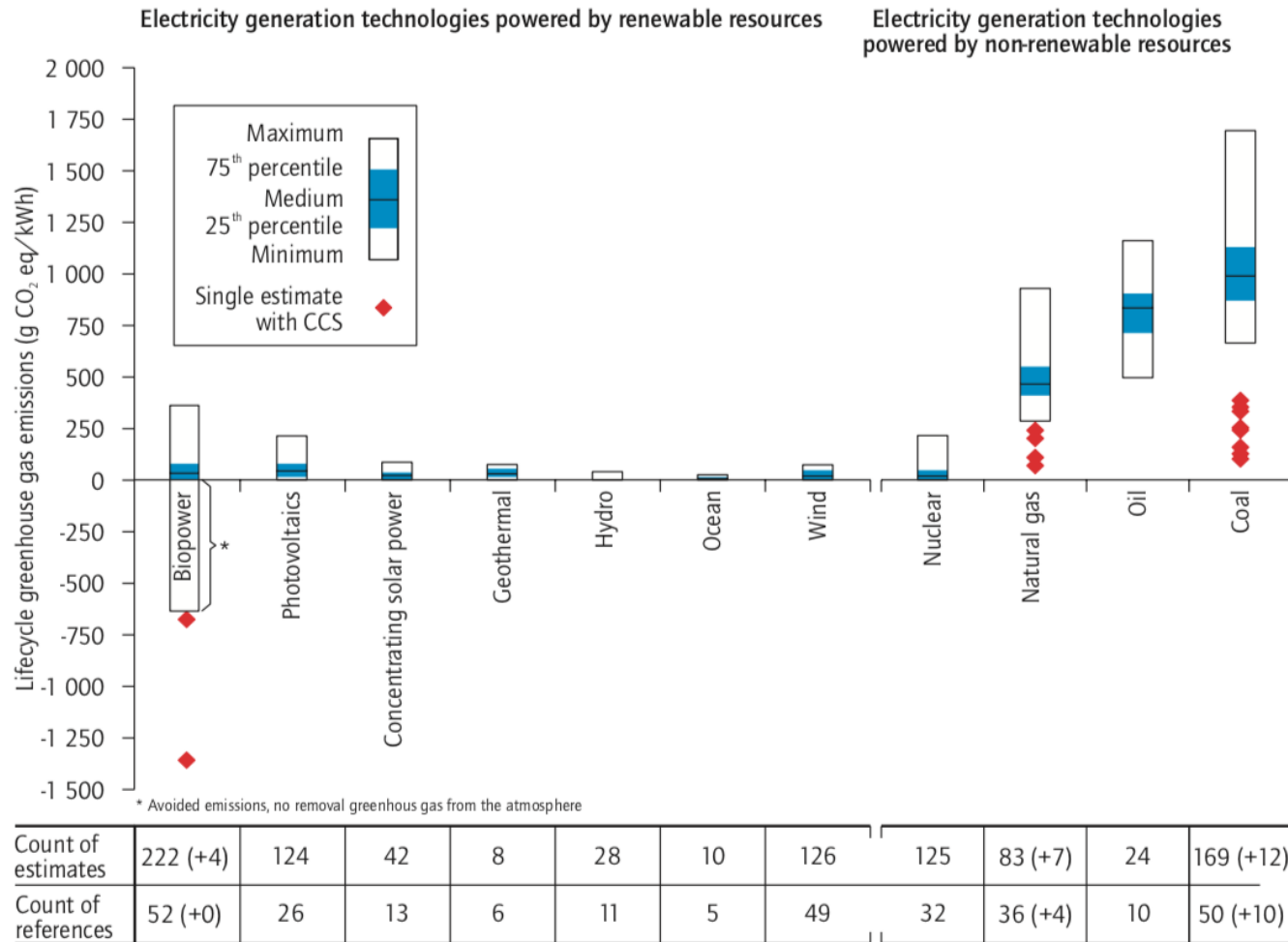

Hydro and energy systems

Impacts : fatalities

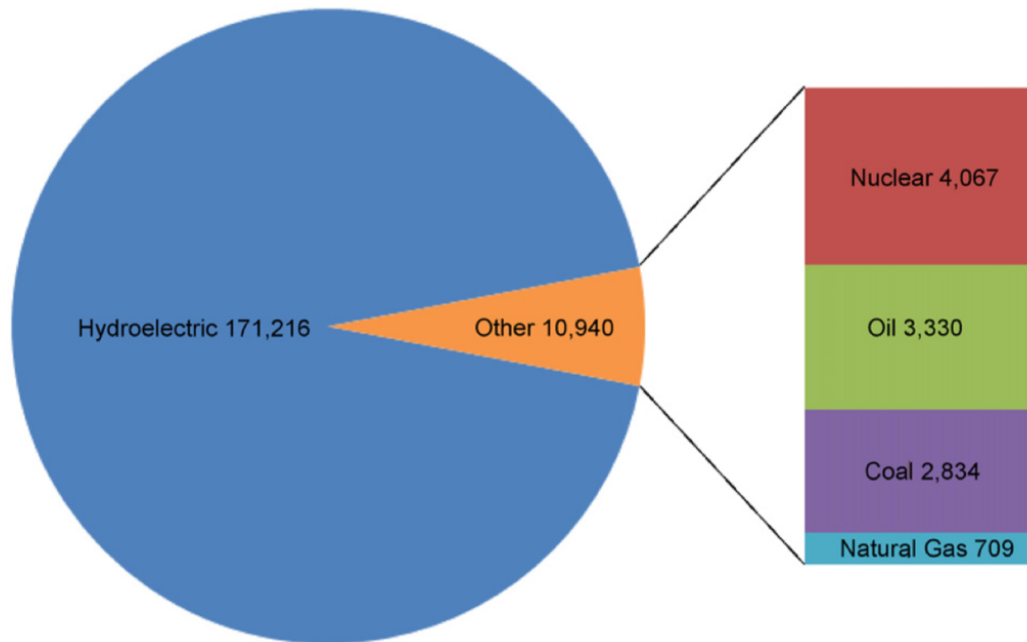

Fig. 1. Energy accident fatalities by source, 1907–2007.

Energy Source	[deaths/ PWh]
Coal – global average	100000
Coal – China	170000
Coal – U.S.	10000
Oil	36000
Natural Gas	4000
Biofuel/Biomass	24000
Solar (rooftop)	440
Wind	150
Hydro – global average	1400
Hydro – U.S.	5
Nuclear – global average	90
Nuclear – U.S.	0.1

Hydro and energy systems

Model used in the project (Energy Scope)

- Representation of the **real** situation in CH (2012):
 - HYDRO_DAM and HYDRO_RIVER technologies
 - Production by hydro dams (8.08 GWe) + run-of-river (3.8 GWe)
 - LEaux law effect for river protection (minimum flow rates) → -1400 GWh/y
 - Monthly profiles already optimized for seasonal storage (6500 GWh/y)

	f_{ref} [GW]	c_{inv} [CHF ₂₀₁₅ /kWe]	c_{maint} [CHF ₂₀₁₅ /kWe/y]	gwp_{constr} [kgCO ₂ -eq./kWe]	Lifetime [y]	c_p [%]	f_{min} [GW]	f_{max} [GW]
Solar PV	3.00e-06	1000 ^a	15.9 ^a	2081 [168]	25 [172]	11.3 ^b	0	25 ^c
Wind Turbine	3.00e-03	1466 ^d	23.9 ^d	622.9 [168]	20 [176]	23.0 ^e	0	5.30 ^f
Existing Hydro Dam	8.08	4828 [181]	24.1 [181]	1693 [168]	40 [181]	23.4	8.08 [182]	8.08 [182]
New Hydro Dam ^g	1.00e-3	3437	2.89				0	0.44
Existing Hydro River	3.80	5387 [181]	53.9 [181]	1263 [168]	40 [181]	48.4	3.80 [182]	3.80 [182]
New Hydro River ^g	1.00e-04	5919	76.3				0	0.85
Geothermal ^h	7.6e-03	11464	465	2.493e01 [168]	30	86 [183]	0	0.70 ⁱ

Hydro and energy systems

Model used in the project (Energy Scope)

- Representation of the **future** situation in CH:
 - NEW_HYDRO_DAM and NEW_HYDRO_RIVER technologies
 - Dams: +900 GWh/y (0.44 GW_e) + 5%
 - Rivers: +3600 GWh/y (0.85 GW_e) + 20%
 - PUMPED_HYDRO: if we choose to install new dams, we also have +2400 GWh/y (total 8900 GWh/y) for **shifting** production summer → winter

	Hydro river			Hydro dam		
	Power [GW]	<i>c_{inv}</i> [CHF ₂₀₁₅ /kW _e]	Total Inv. [10 ⁶ CHF ₂₀₁₅]	Power [GW]	<i>c_{inv}</i> [CHF ₂₀₁₅ /kW _e]	Total Inv. [10 ⁶ CHF ₂₀₁₅]
Renovation	0.16	4278 [189]	683	0.23	2849 [189]	643
Dam height increase	-	-	-	0.16	3807	612 ^a
New big plants [181]	0.31	5387	1681	0.05	4828	254
New small plants	0.38	7054 ^b	2660	-	-	-
Total	0.85	5919	5023	0.44	3437	1509



Take-home message

Take-home message

- In general
 - Hydro most developed renewable
 - Key resource in CH
 - Run-of-river & storage power plants
- Physics
 - Specific energy depends on **head** [m]
 - Total power depends on head & **discharge**
 - **Specific speed** v to characterize turbines
- Hydraulic turbines
 - **Pelton**: high head, low discharge
 - **Francis** (60%): medium head/discharge
 - **Kaplan/Bulb**: low head, high discharge
- Energy system integration
 - Competitive for cost/GHG

$$gH_1 - gH_2 = g(z_U - z_L) - \sum gH_r$$

$$v = \frac{\omega Q^{\frac{1}{2}}}{\pi^{\frac{1}{2}} (2e)^{\frac{3}{4}}} \quad \dot{E} = \rho v_x A g H_x$$

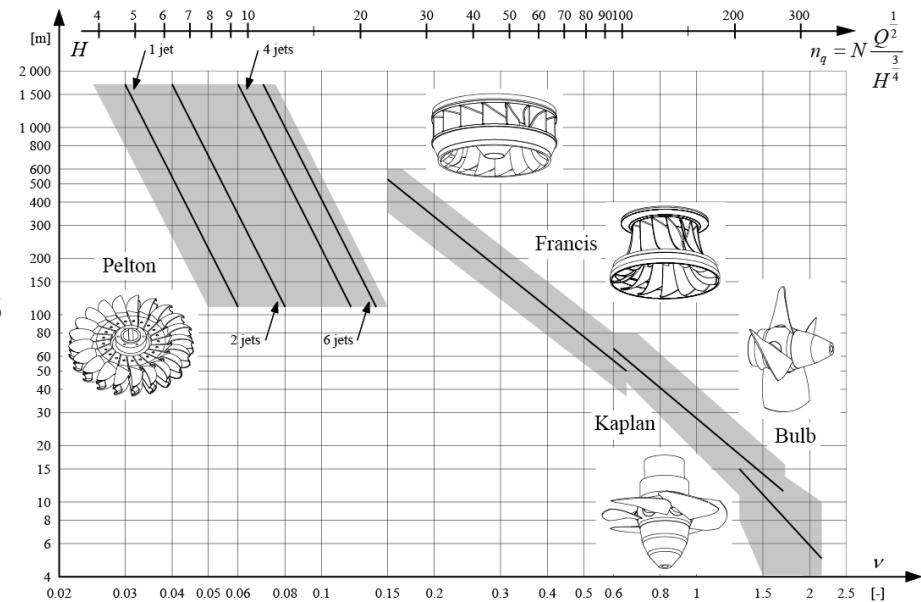

EPFL



Questions?

Prof. François
Maréchal